

HIGH VOLTAGE APPLICATION.

FEATURES

- High Voltage : $V_{CEO} = -150V$.
- Low Output Capacitance : $C_{ob} = 5.0pF(\text{Max.})$.
- High Transition Frequency : $f_T = 120MHz(\text{Typ.})$.
- Complementary to KTC3206.

MAXIMUM RATING (Ta=25°C)

CHARACTERISTIC	SYMBOL	RATING	UNIT
Collector-Base Voltage	V_{CBO}	-150	V
Collector-Emitter Voltage	V_{CEO}	-150	V
Emitter-Base Voltage	V_{EBO}	-5	V
Collector Current	I_C	-50	mA
Emitter Current	I_E	50	mA
Base Current	I_B	-5	mA
Collector Power Dissipation	P_C	1	W
Junction Temperature	T_j	150	°C
Storage Temperature Range	T_{stg}	-55 ~ 150	°C

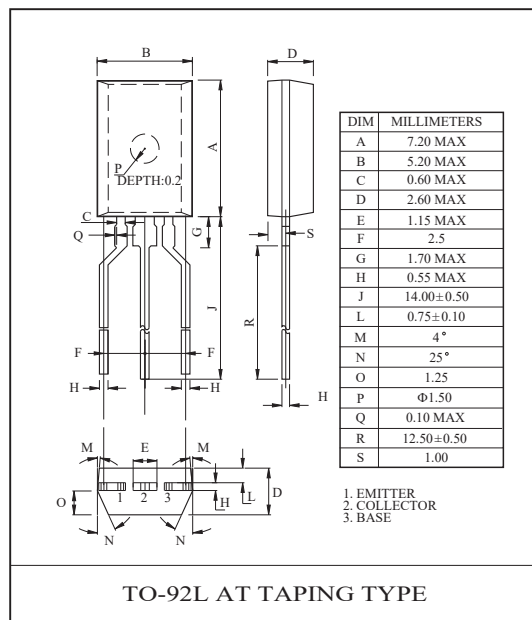
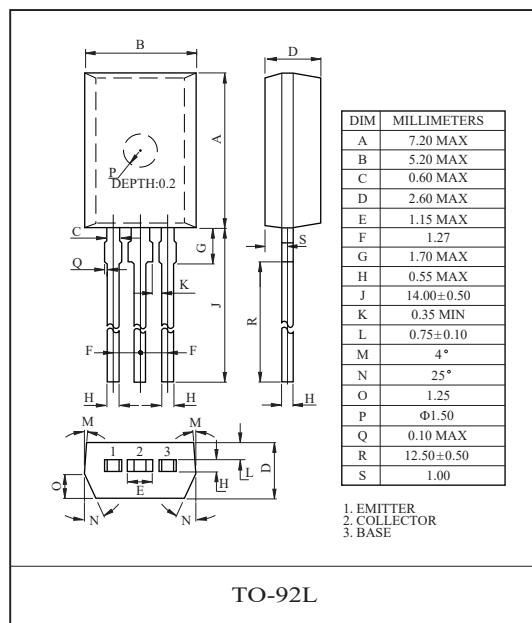

ELECTRICAL CHARACTERISTICS (Ta=25°C...)

CHARACTERISTIC	SYMBOL	TEST CONDITION	MIN.	TYP.	MAX.	UNIT
Collector Cut-off Current	I_{CBO}	$V_{CB} = -150V, I_E = 0$	-	-	-0.1	μA
Emitter Cut-off Current	I_{EBO}	$V_{EB} = -5V, I_C = 0$	-	-	-0.1	μA
DC Current Gain	$h_{FE}(\text{Note})$	$V_{CE} = -5V, I_C = -10mA$	70	-	240	
Collector-Emitter Saturation Voltage	$V_{CE(sat)}$	$I_C = -10mA, I_B = -1mA$	-	-	-0.8	V
Base-Emitter Voltage	V_{BE}	$V_{CE} = -5V, I_C = -30mA$	-	-	-0.9	V
Transition Frequency	f_T	$V_{CE} = -30V, I_C = -10mA$	-	120	-	MHz
Collector Output Capacitance	C_{ob}	$V_{CB} = -10V, I_E = 0, f = 1MHz$	-	4.0	5.0	pF

Note : h_{FE} Classification O:70 ~ 140, Y:120 ~ 240

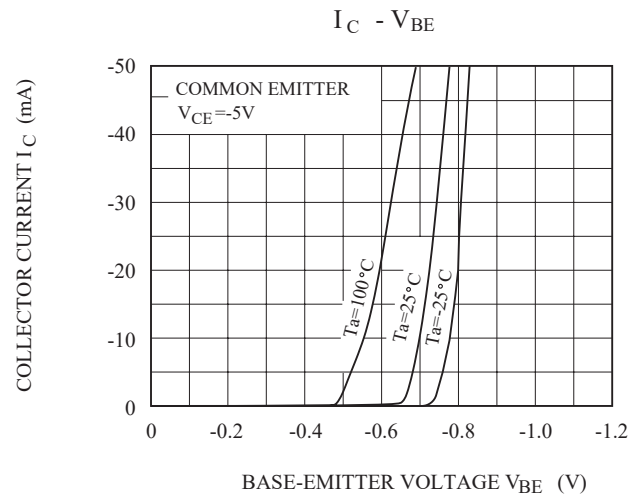
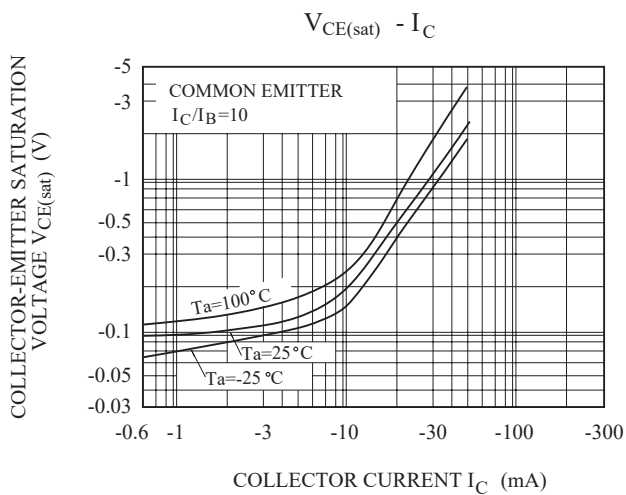
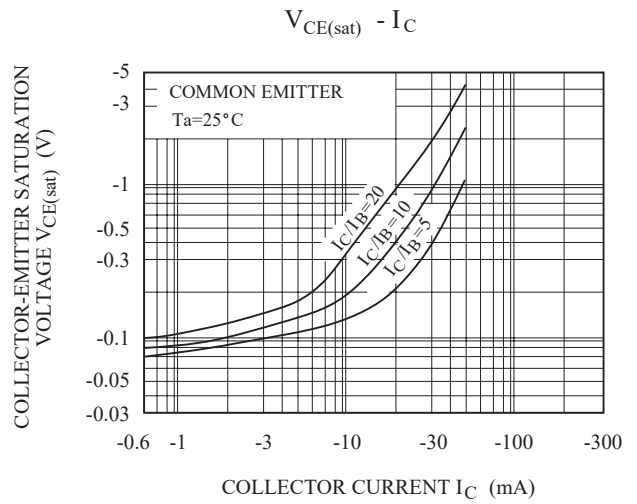
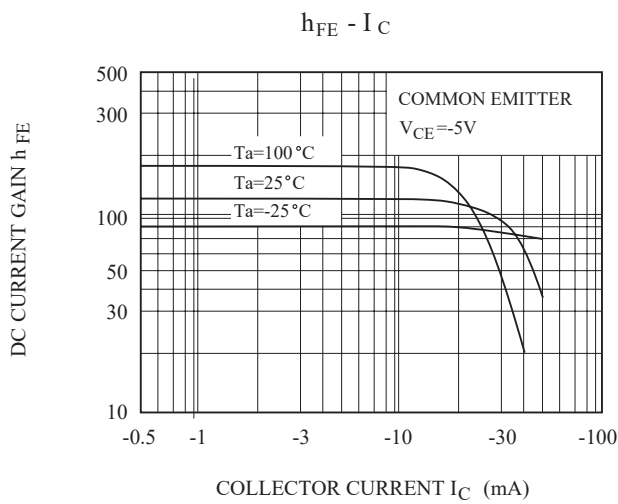
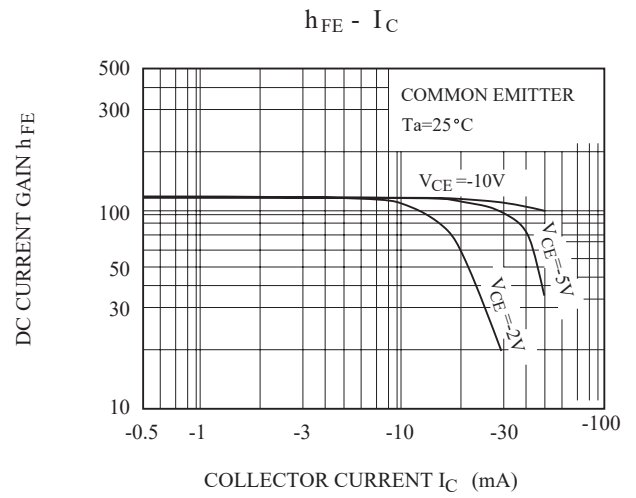
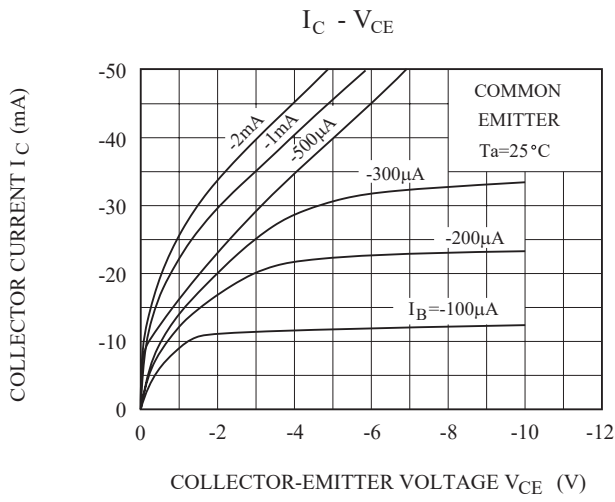

KTA1024

SAFE OPERATING AREA

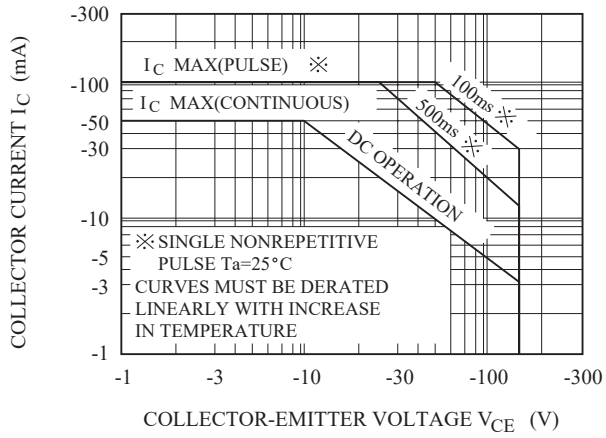

Pc - Ta

