

### Protection in Portable Electronics Applications.

### FEATURES

- Transient protection for data lines to
  - IEC61000-4-2(ESD) : Air mode  $\pm 25\text{kV}$  / Contact mode  $\pm 20\text{kV}$
  - IEC61000-4-5(Surge) :  $7\text{A}(t_p=8/20\ \mu\text{s})$
- Low capacitance  $C_T = 9\text{pF}(\text{Max})$
- Bi-directional, symmetrical working voltage up to :  $V_{RWM} = \pm 3.3\text{V}$
- Extremely small Size  $0.6 \times 0.3 \times 0.3\text{mm}$
- Low reverse current :  $10\text{nA}$  typical ( $V_{RWM}=3.3\text{V}$ )



ELP-2A (leadless-type)

### PRODUCT DESCRIPTION

- Molding compound flammability rating : UL 94V-0
- Pb-Free, Halogen-Free, RoHs Compliant

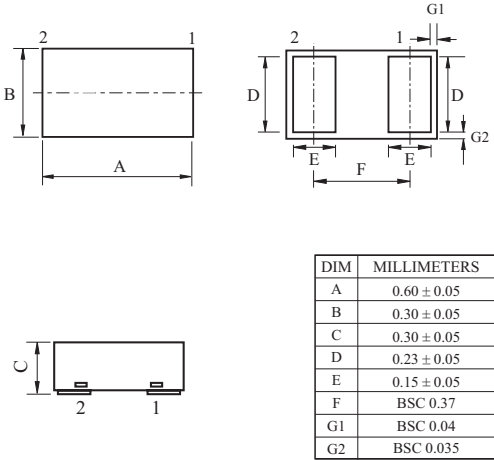
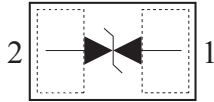
Package dimensions (ELP-2A)	Pin configurations (Bi-directional)																		
 <table border="1" data-bbox="510 1489 694 1702"> <thead> <tr> <th>DIM</th> <th>MILLIMETERS</th> </tr> </thead> <tbody> <tr> <td>A</td> <td><math>0.60 \pm 0.05</math></td> </tr> <tr> <td>B</td> <td><math>0.30 \pm 0.05</math></td> </tr> <tr> <td>C</td> <td><math>0.30 \pm 0.05</math></td> </tr> <tr> <td>D</td> <td><math>0.23 \pm 0.05</math></td> </tr> <tr> <td>E</td> <td><math>0.15 \pm 0.05</math></td> </tr> <tr> <td>F</td> <td>BSC 0.37</td> </tr> <tr> <td>G1</td> <td>BSC 0.04</td> </tr> <tr> <td>G2</td> <td>BSC 0.035</td> </tr> </tbody> </table>	DIM	MILLIMETERS	A	$0.60 \pm 0.05$	B	$0.30 \pm 0.05$	C	$0.30 \pm 0.05$	D	$0.23 \pm 0.05$	E	$0.15 \pm 0.05$	F	BSC 0.37	G1	BSC 0.04	G2	BSC 0.035	 <p>1. ANODE    2. ANODE</p>
DIM	MILLIMETERS																		
A	$0.60 \pm 0.05$																		
B	$0.30 \pm 0.05$																		
C	$0.30 \pm 0.05$																		
D	$0.23 \pm 0.05$																		
E	$0.15 \pm 0.05$																		
F	BSC 0.37																		
G1	BSC 0.04																		
G2	BSC 0.035																		

### ORDERING INFORMATION

Part Number	Qty per Reel	Reel Size	Marking code
PS03CBEL2A-RTK	5,000	7 inch	M
PS03CBEL2A-RTL	10,000		
PS03CBEL2A-RTH	5,000		
PS03CBEL2A-RTR	10,000		

# PS03CBEL2A

## MAXIMUM RATING (Ta=25 )

CHARACTERISTIC	SYMBOL	RATING	UNIT
Peak Pulse Power (tp=8/20 μs)	P <sub>PK</sub>	70	W
Peak Pulse Current (tp=8/20 μs)	I <sub>PP</sub>	7	A
Junction Temperature	T <sub>J</sub>	150	
Storage Temperature	T <sub>stg</sub>	-55 150	

## DEFINITIONS OF ELECTRICAL CHARACTERISTIC SYMBOL

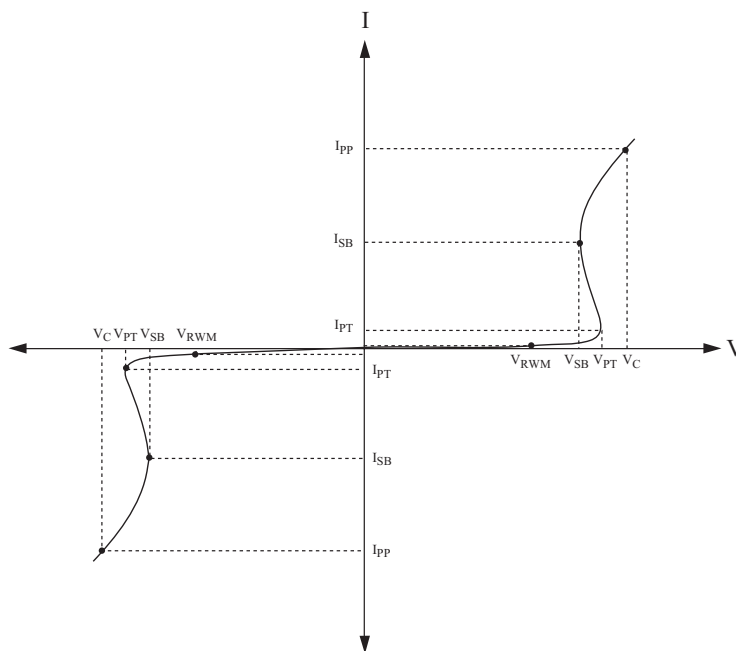

## ELECTRICAL CHARACTERISTICS (Ta=25 )

CHARACTERISTIC	SYMBOL	TEST CONDITION	MIN.	TYP.	MAX.	UNIT	
Reverse Stand-Off Voltage	V <sub>RWM</sub>	-	-	-	3.3	V	
Reverse Leakage Current	I <sub>R</sub>	V <sub>RWM</sub> =3.3V	-	10	50	nA	
Snap-back Voltage	V <sub>SB</sub>	I <sub>SB</sub> =100uA, I <sub>SB</sub> =50mA	3.4	-	-	V	
Punch-through Voltage	V <sub>PT</sub>	I <sub>PT</sub> =2 μA	3.5	4	4.4	V	
Total Capacitance	C <sub>T</sub>	V <sub>R</sub> =0V, f=1MHz	-	6	9	pF	
Clamping Voltage	V <sub>C</sub>	I <sub>PP</sub> =1A, tp=8/20 μs	-	-	5.5	V	
		I <sub>PP</sub> =4A, tp=8/20 μs	-	-	7.5		
		I <sub>PP</sub> =7A, tp=8/20 μs	-	-	10		
		I <sub>TLP</sub> =4A, tp=100ns	-	10	15		
		I <sub>TLP</sub> =24A, tp=100ns	-	12	17		
Electrostatic Discharge	V <sub>ESD</sub>	IEC61000-4-2	Air	± 25	-	-	kV
			Contact	± 20	-	-	

# PS03CBEL2A

NON-REPETITIVE PEAK PULSE  
POWER VS. PULSE TIME

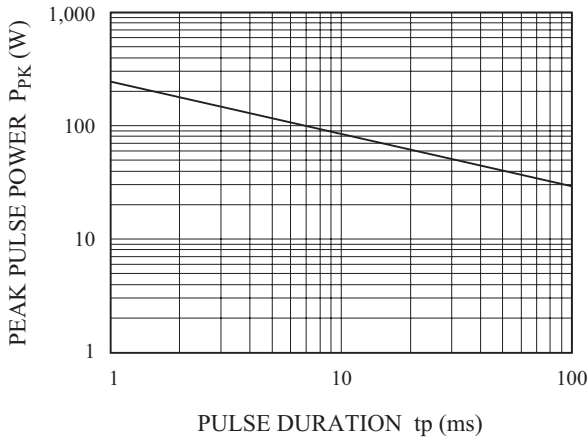

POWER DERATION CURVE

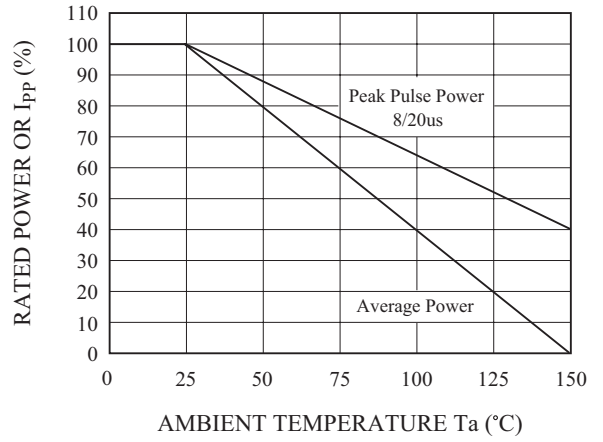

$I_R - V_R$

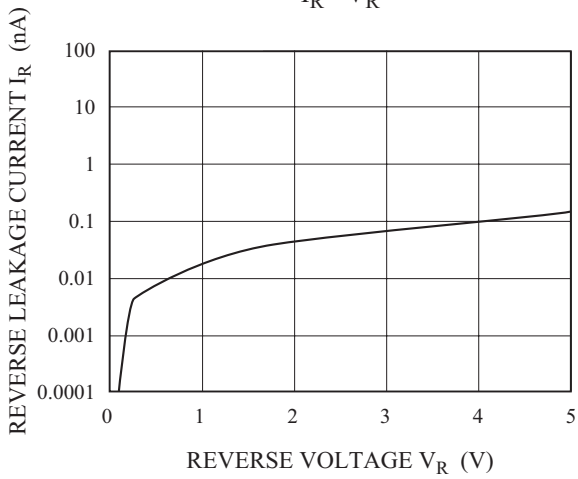

$C_T - V_R$

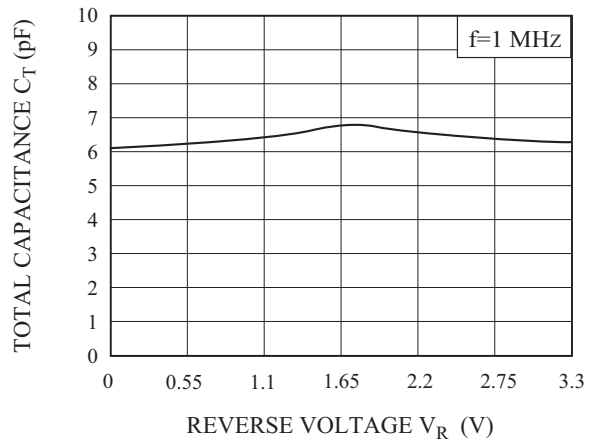

$I_{PP} - V_C$

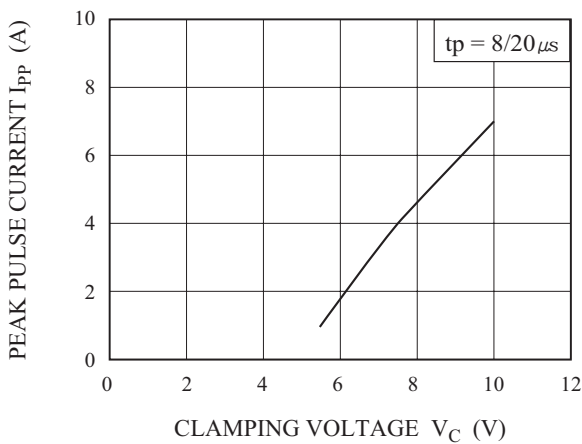

$I_{TLP} - V_C$

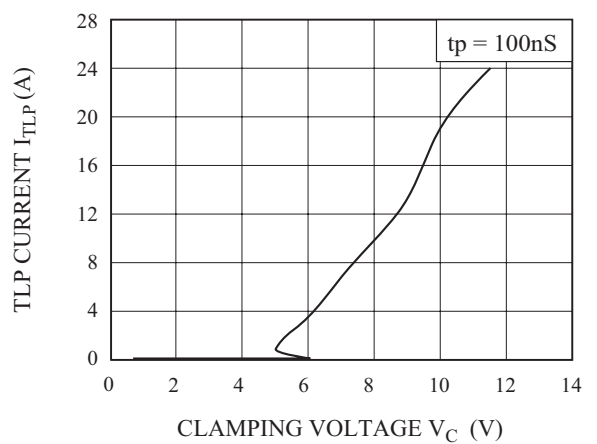

# PS03CBEL2A

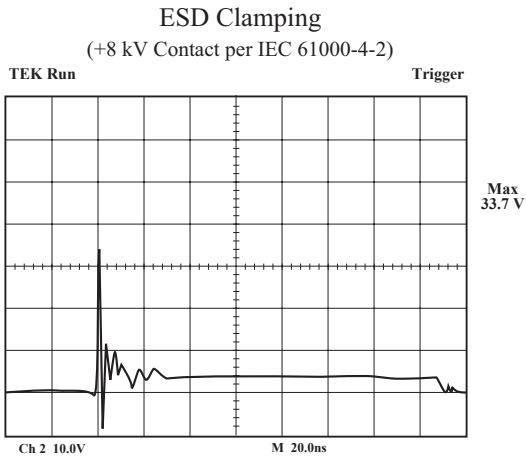

Note : Data is taken with a 10x attenuator

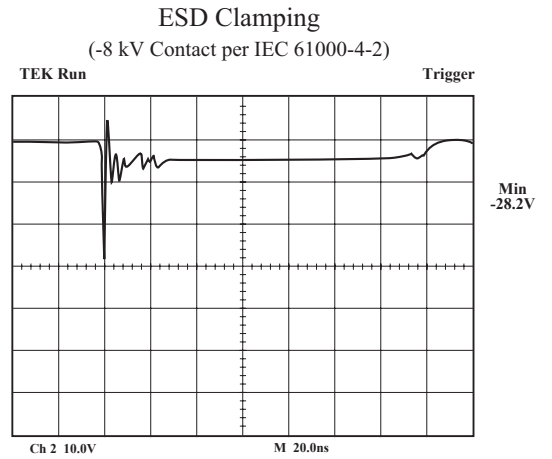

Note : Data is taken with a 10x attenuator

## PULSE WAVEFORM

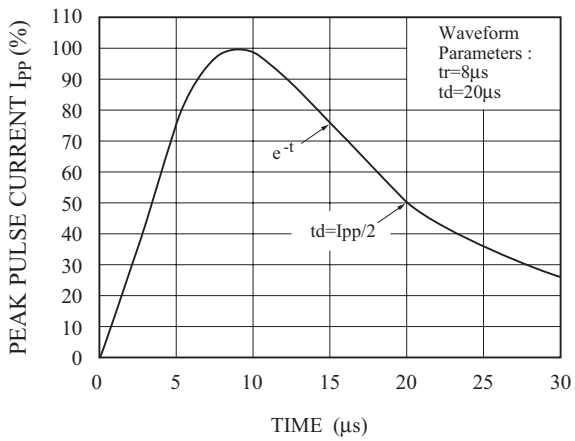

# PS03CBEL2A

## APPLICATIONS

- USB 2.0, 10/100/1000 Ethernet, DVI, HDMI, S-ATA
- MDDI Port
- LCD-Display, Camera
- GPS / FM Antennas
- LVDS
- High speed data lines

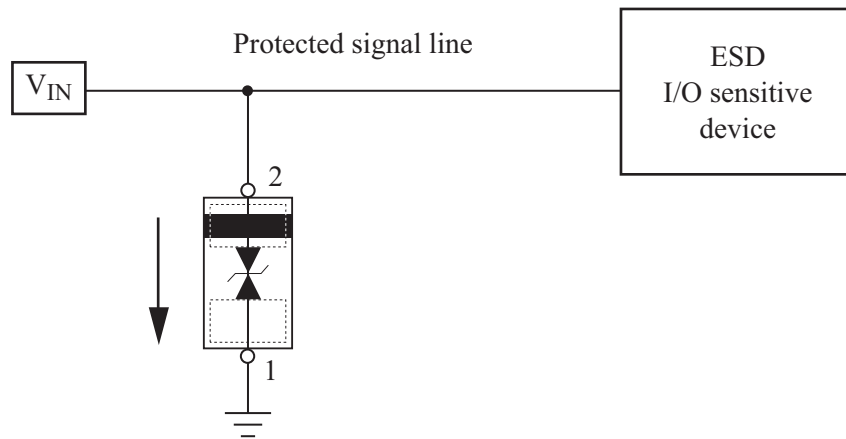

## Recommended pad dimension & Marking Information

Recommended pad dimension	Marking Code