

Protection in Portable Electronics Applications.

FEATURES

- Transient protection for data lines to
 - IEC61000-4-2(ESD) : Air mode $\pm 25\text{kV}$ /Contact mode $\pm 20\text{kV}$
 - IEC61000-4-4(FET) : $\pm 50\text{A}(5/50\text{ns})$
 - IEC61000-4-5(Surge) : $4\text{A}(t_p=8/20 \mu\text{s})$
- Low capacitance $C_T = 0.5\text{pF}(\text{Max})$
- Bi-directional, symmetrical working voltage up to : $V_{RWM} = \pm 5\text{V}$
- Extremely small size $0.6 \times 0.3 \times 0.3\text{mm}$
- Low reverse current : $< 5\text{nA}$ typical($V_R=5\text{V}$)



ELP-2D(1) (leadless-type)

PRODUCT DESCRIPTION

- Molding compound flammability rating : UL 94V-0
- Pb-Free, Halogen-Free, RoHs Compliant

Package dimensions (ELP-2D(1))	Pin configurations (Bi-directional)																						
<table border="1"> <thead> <tr> <th>DIM</th> <th>MILLIMETERS</th> </tr> </thead> <tbody> <tr><td>A</td><td>0.6 ± 0.04</td></tr> <tr><td>B</td><td>0.3 ± 0.04</td></tr> <tr><td>C</td><td>0.3 ± 0.05</td></tr> <tr><td>D</td><td>0.24 ± 0.04</td></tr> <tr><td>E1</td><td>0.16 ± 0.03</td></tr> <tr><td>E2</td><td>0.16 ± 0.03</td></tr> <tr><td>F</td><td>Typ 0.36</td></tr> <tr><td>G1</td><td>Typ 0.04</td></tr> <tr><td>G2</td><td>Typ 0.03</td></tr> <tr><td>G3</td><td>Typ 0.04</td></tr> </tbody> </table>	DIM	MILLIMETERS	A	0.6 ± 0.04	B	0.3 ± 0.04	C	0.3 ± 0.05	D	0.24 ± 0.04	E1	0.16 ± 0.03	E2	0.16 ± 0.03	F	Typ 0.36	G1	Typ 0.04	G2	Typ 0.03	G3	Typ 0.04	<p>1. CATHODE 2. CATHODE</p>
DIM	MILLIMETERS																						
A	0.6 ± 0.04																						
B	0.3 ± 0.04																						
C	0.3 ± 0.05																						
D	0.24 ± 0.04																						
E1	0.16 ± 0.03																						
E2	0.16 ± 0.03																						
F	Typ 0.36																						
G1	Typ 0.04																						
G2	Typ 0.03																						
G3	Typ 0.04																						

ORDERING INFORMATION

Part Number	Qty per Reel	Reel Size	Marking code
PS05TBEL2D-RTL	10,000	7 inch	S

PS05TBEL2D

MAXIMUM RATING (Ta=25°C)

CHARACTERISTIC	SYMBOL	RATING	UNIT
Peak Pulse Power(tp=8/20 μs)	P _{PK}	60	W
Peak Pulse Current(tp=8/20 μs)	I _{PP}	4	A
Junction Temperature	T _J	150	°C
Storage Temperature	T _{STG}	-55 ~ 150	°C

DEFINITIONS OF ELECTRICAL CHARACTERISTIC SYMBOL

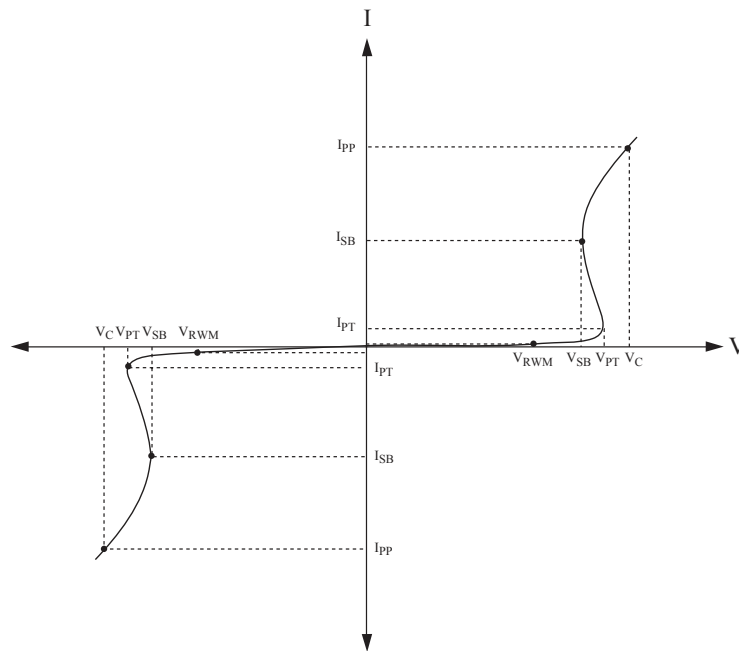

ELECTRICAL CHARACTERISTICS (Ta=25°C)

CHARACTERISTIC	SYMBOL	TEST CONDITION	MIN.	TYP.	MAX.	UNIT	
Reverse Stand-Off Voltage	V _{RWM}	-	-	-	5	V	
Reverse Leakage Current	I _R	V _{RWM} =5V	-	5	100	nA	
Snap-back Voltage	V _{SB}	I _{SB} =100 μA, I _{SB} =50mA	5.5	-	-	V	
Punch-through Voltage	V _{PT}	I _{PT} =2 μA	6	8	10	V	
Total Capacitance	C _T	V _R =0V, f=1MHz	-	0.3	0.5	pF	
Clamping Voltage	V _C	I _{PP} =1A, tp=8/20 μs	-	10	13	V	
		I _{PP} =4A, tp=8/20 μs	-	12	15	V	
		I _{TLF} =4A, tp=100ns	-	10	15	V	
		I _{TLF} =24A, tp=100ns	-	22	27	V	
Electrostatic Discharge	V _{ESD}	IEC61000-4-2	Air	±25	-	-	kV
			Contact	±20	-	-	

PS05TBEL2D

NON-REPETITIVE PEAK PULSE
POWER VS. PULSE TIME

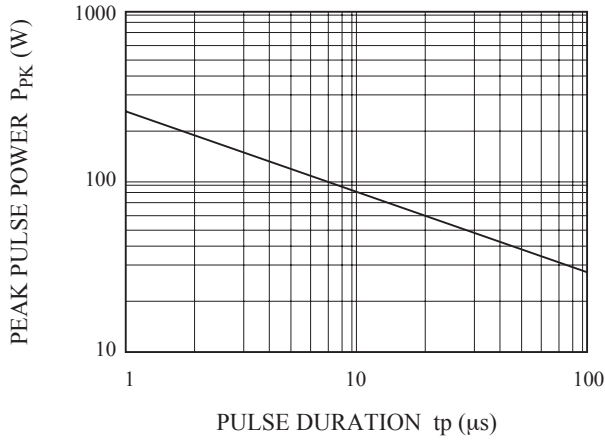

POWER DERATION CURVE

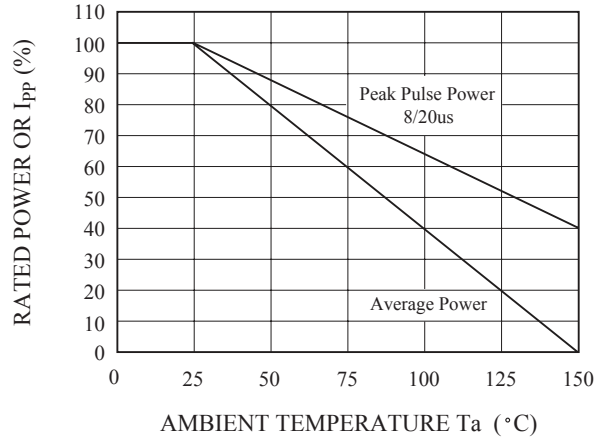

I_R - V_R

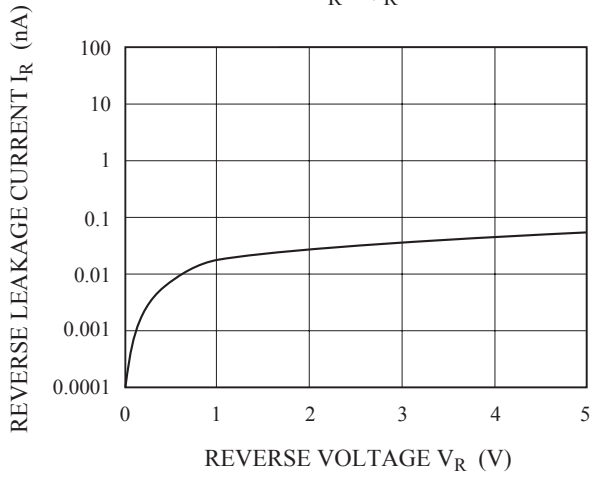

C_T - V_R

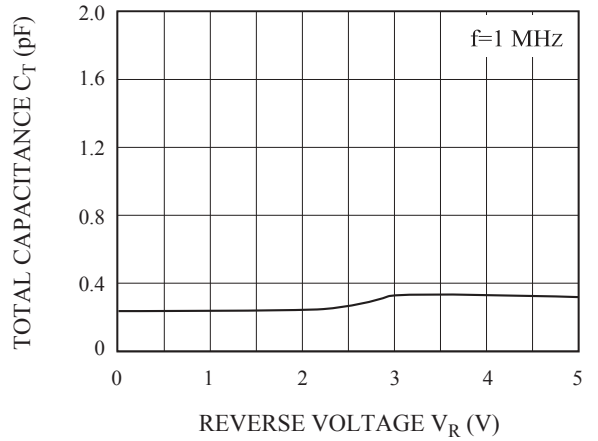

I_{PP} - V_C

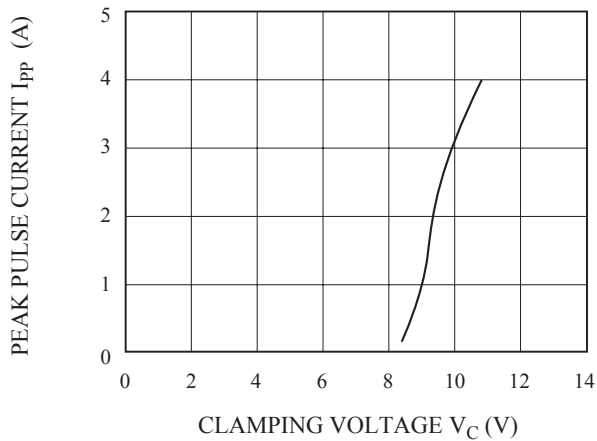

I_{TLP} - V_C

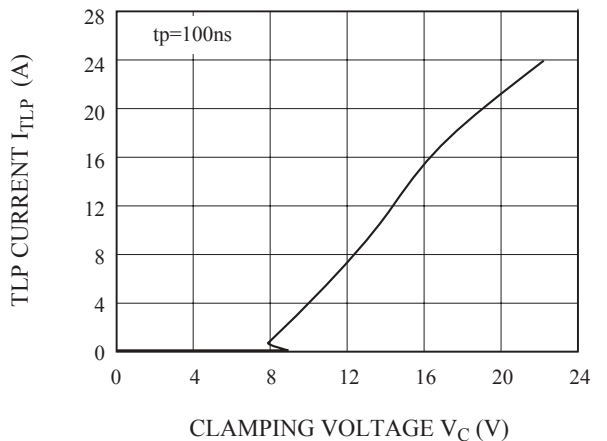

PS05TBEL2D

ESD Clamping
(+8 kV Contact per IEC 61000-4-2)

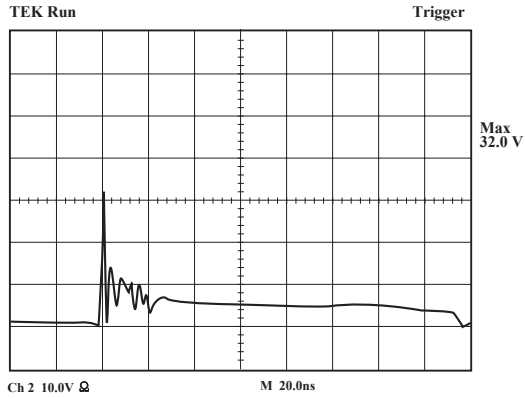

Note : Data is taken with a 10x attenuator

ESD Clamping
(-8 kV Contact per IEC 61000-4-2)

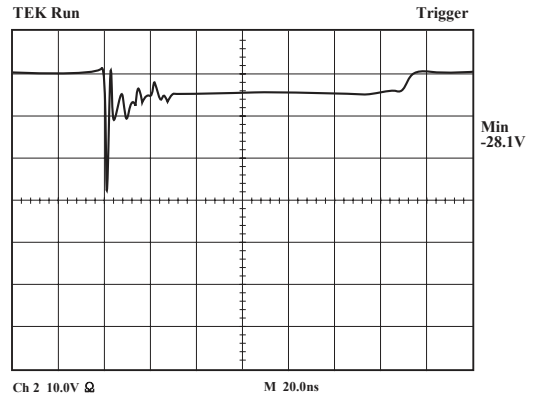

Note : Data is taken with a 10x attenuator

PULSE WAVEFORM

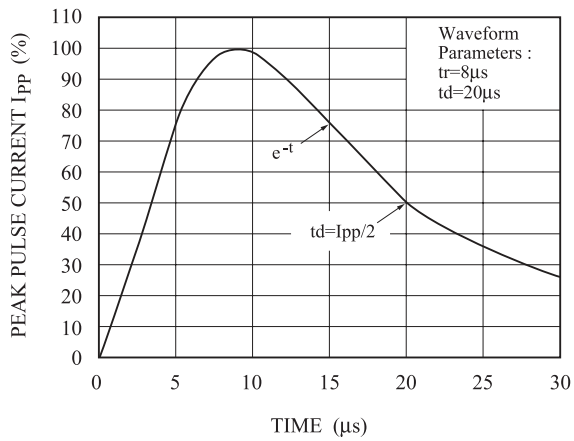

PS05TBEL2D

APPLICATIONS

- USB2.0, USB3.0, 10/100/1000 Ethernet, DVI, HDMI, S-ATA
- MDDI Port
- LCD-Display, Camera
- GPS/FM Antennas
- LVDS
- High speed data line

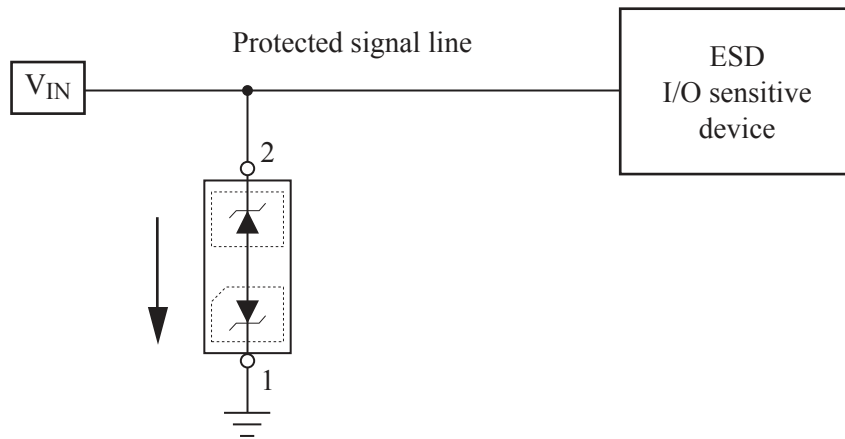

Recommended pad dimension & Marking Information

Recommended pad dimension	Marking Code
<p>The diagram shows two square pads. The width of each pad is 0.26. The height of each pad is 0.27. The distance between the centers of the two pads is 0.39.</p>	<p>The diagram shows the marking code 'S' on the device. The cathode mark is indicated by a vertical bar on the left side of the device, labeled 'CATHODE MARK'. The terminals are labeled 1 and 2.</p>

PS05TBEL2D

PRECAUTION ON USING KEC PRODUCTS

1. The products described in this data are intended to be used in general-purpose electronic equipment (Office equipment, telecommunication equipment, measuring equipment, home appliances)
2. When you intend to use these products with equipment or device which require an extremely high of reliability and special applications (such as automobile, air travel aerospace, transportation equipment, life support, system and safety devices) in which special quality and reliability and the failure or malfunction of products may directly jeopardize or harm the human body or damage to property and any application other than the standard application intended, please be sure to consult with our sales representative in advance.
3. On designing your application, please use product within the ranges guaranteed by KEC for maximum rating, operating supply voltage range, heat radiation characteristics and other characteristics. User shall be responsible for failure or damage when used beyond the guaranteed ranges.
4. The technical information described in this data is limited to showing representative characteristics and applied circuit examples of the products and it does not constitute the warranting of industrial property, the granting of relative rights, or the granting of any license.
5. What are described in the data may be changed without any prior notice to reflect new technical development. Please confirm that you have received the latest product standards or specification before final design, purchase or use.
6. Although KEC is continuously working to improve product reliability and quality, semiconductors can break down and malfunction due to various factors. Therefore, in order to prevent personal injury or fire arising from failure, please take safety measures such as complying with the derating characteristics, implementing redundant and fire prevention designs, and utilizing backups and fail-safe procedures. KEC shall have no responsibility for any damages arising out of the use of our Products beyond the rating specified by KEC.